

INFINUVO

CleanMate

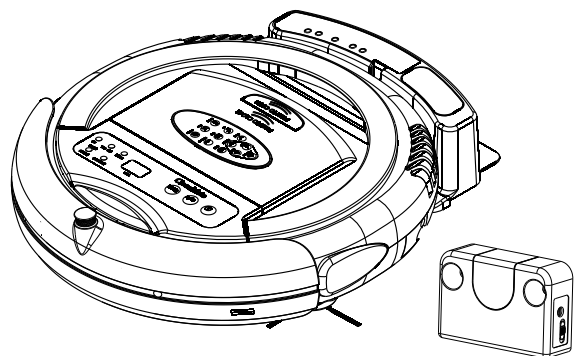

INFINUVO

CleanMate

QQ2 Plus Series

Robotic Vacuum Cleaner

USER MANUAL

QQ2 Plus Series

Robotic Vacuum Cleaner

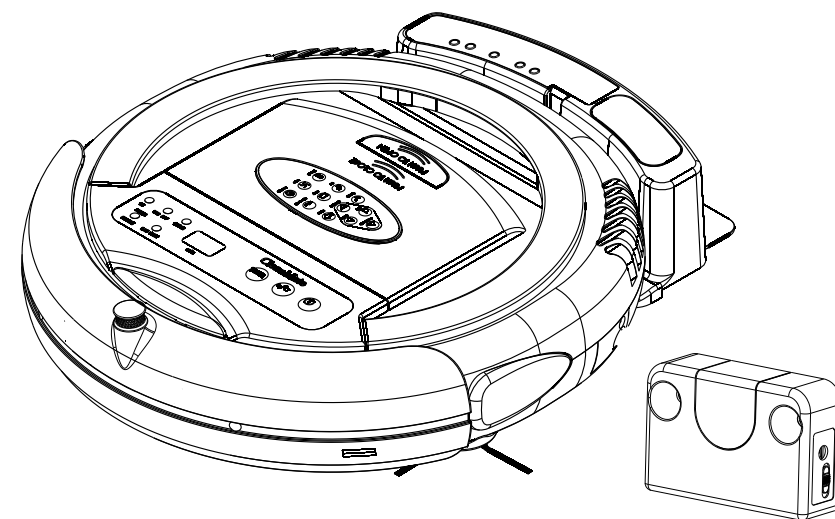

If you have question or issue on the product, do not return it to store.

Please contact technical support first with live chat at: <http://cleanmate.metapo.com>

REV.A 011613II

Table of Content

Safety Precautions	1
Safety Instructions	1
Special Features	2
Cautions	3
Main Unit and Accessories	4
Main Unit Features	5
Remote Control Functions	7
Battery Installation and Removal	8
Sonic Wall Setup	9
Self Charging Home Base	10
Scheduler Operations	11
Installing Accessories	14
General Operation	16
Cleaning and Maintenance	17
Useful Tips	21
Specification	23
Troubleshooting	24
Warranty Policy	25

Safety Precautions

QQ2 Plus Series

**** Before using this product, please remove 2 white protection pads inside front bumper. ****

Please follow all normal safety precautions to avoid the occurrence of situations such as fire, short-circuit, and injury.

Please make sure that you observe all the following safety precautions:

Safety Instruction

QQ2 Plus Series

1. Read this user manual thoroughly before using this product.
2. This product is not for use outdoors.
3. This product is an electronic device. Never get it wet or let it come in contact with water. Do not use it in a moist or wet environment.
4. Before using this product, please tidy up things on the floor. You must remove all objects that could get caught in the rolling brush or in the air intake on the bottom of the unit. Examples include, clothing, power cords, cable, telephone cords, drapes of blinds, loose fringes of rugs. These items can get caught in the unit, and either prevent it from moving, or the unit could pull over a lamp, table, or chair (for examples) and cause damage to the unit, floor, object, or person.
5. Please do not sit or stand on this product. Pay special attention to toddlers or pets in the house to prevent harm to the unit or the child, pet or the unit.
6. Please do not use this product to clean a still-burning cigarette, a lit match.
7. Please do not use this product to clean flammable or highly volatile liquids such as gasoline or white gasoline.
8. To prevent damage to the vacuum, make sure that nothing is obstructing the air vents on the top of the unit.
9. When was not in use for long period, please charging battery, minimum one time during 2 months.
10. Use the factory-provided batteries and charger. If battery was over lifespan, please renew same type and rating of battery. Please ask your distributor.
11. When your hands are moist, do not touch the battery charger, plug or power cord.
12. When you need to clean this product, stop charging, and remove the Battery.

Special Features

QQ2 Plus Series

1. This product is a revolutionary robotic vacuum cleaner. It utilizes high vacuum suction, a roller brush on the bottom, a side brush for cleaning along walls and other objects, an ultraviolet light to help with disinfection, and even has a compartment for adding fragrance to the air as it cleans. All of these features make this unit perfect for cleaning a wide variety of floor types, including ceramic tile, hardwood, vinyl and most carpets. As long as you have the QQ2 Plus Robotic Vacuum Cleaner, you have the most helpful house cleaning mate.
2. The compact shape enables this unit to clean under beds, tables and other furniture that standard upright vacuums cannot get to.
3. Once the CleanMate is turned on, it will follow a five step repetitive movement: Special bounce, Spiral, Along Wall, "S" shape, and Polygonal Spiral. This wide variety of movement helps to ensure that the unit completely cleans a room.

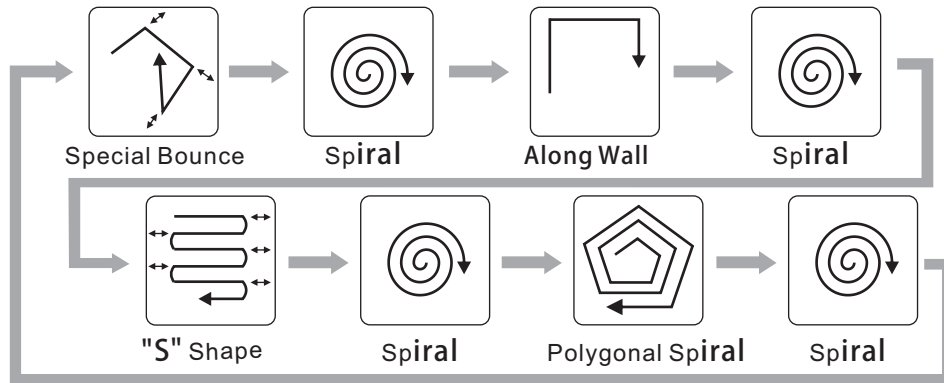

4. "MODE" button on the remote control allows you to select a specific cleaning pattern for the QQ2 Plus. By default the unit operates in Automatic Mode (switching between all 5 patterns), but by using the "MODE" button on the remote, you can select a specific pattern in the following sequence: F1.Spiral F2.Special Bounce F3.Along Wall F4.'S' Shape F5.Polygonal Spiral and back to FA. "Automatic".

Tips : When used "F1" Spiral mode, cleaner will stop when it comes in contact with any objects. It is prevented cleaner can not move away in same location.

5. Sensors will tell the cleaner to back up, turn and clean around the object, when cleaner comes in contact with a wall or other obstacle.

Special Features

QQ2 Plus Series

6. The QQ2 Plus is equipped with a light sensor. When the battery is low, or the cleaning time is completed, the unit will automatically search for the docking station to recharge. If QQ2 Plus can not find the docking station in 30 minutes, QQ2 Plus will stop and turn into "sleep" mode automatically which is to prevent battery run out.
7. There is a transparent window on top of the dust bin. This allows you to easily see how full the dust bin is, so you can clean it out when it is needed. This window also serves as a holder for the remote control to help prevent misplacing or losing the remote control.
8. Photo sensors on the underside of the front of the unit detect stairs, and other drop offs, to keep it from falling off the edge and damaging the unit.
9. A handle is built-in to the unit to make it easy to pick up and move the unit to a different room.

Cautions

QQ2 Plus Series



Do not look directly at the UV light.



Do not touch the UV light bulb with bare hands. Natural skin oils will cause premature failure.
Do not attempt to remove or replace the UV light. This light is a permanent fixture and is not user-replaceable.



Make sure the battery is installed correctly.

Main Unit and Accessories QQ2 Plus Series

Item	Description	QTY
1	QQ2 Plus Series Main Unit	1
2	Remote control	1
3	Filter	2
4	Rechargeable battery	1
5	Charger	1
6	User manual	1
7	Hand brush	1
8	Self charging base	1
9	Fragrance (not included)	
10	Sonic Wall (included for QQ2 Plus II model only)	1

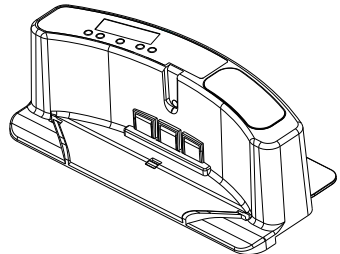
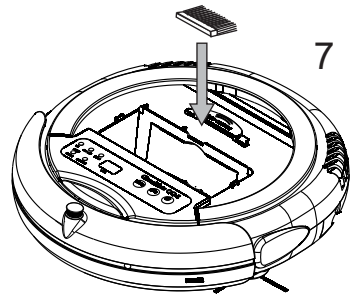
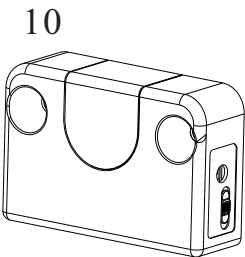
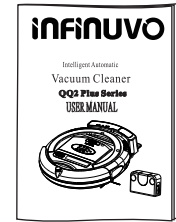
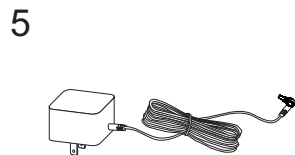
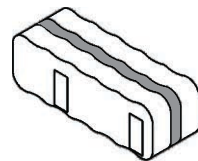
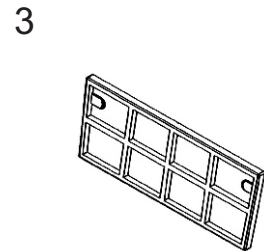
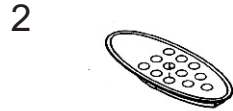
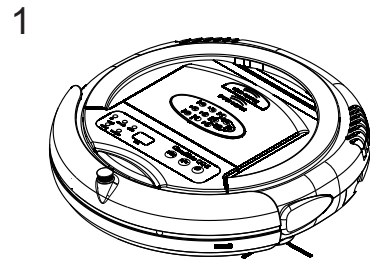

Main Unit Features QQ2 Plus Series

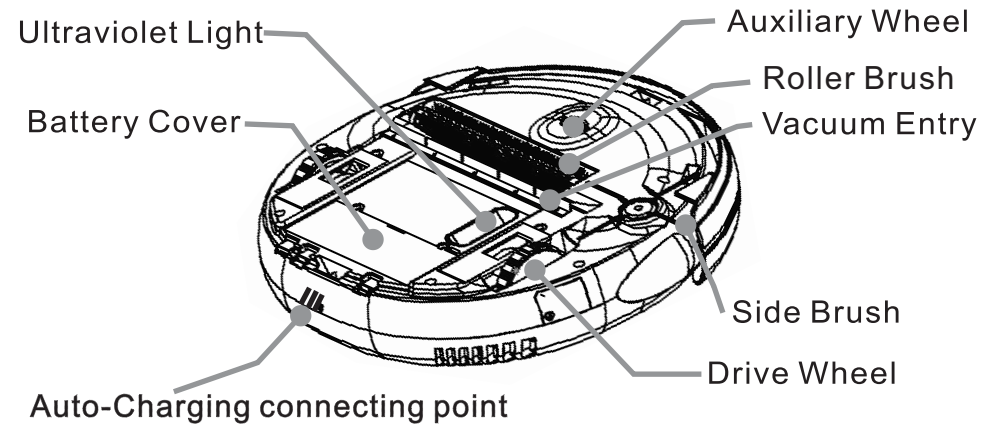
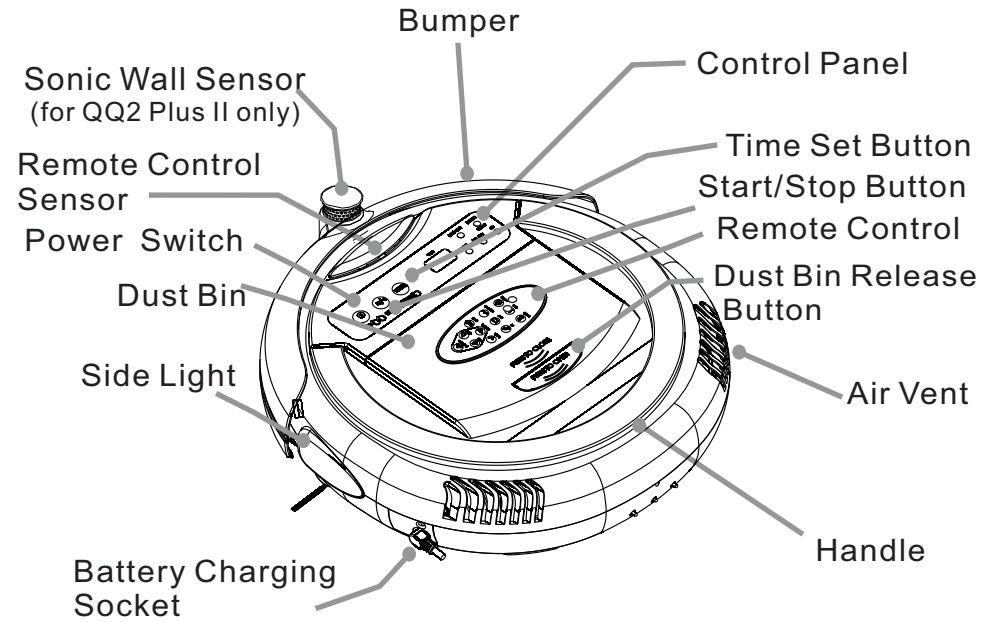

Main Unit Features

QQ2 Plus Series

1. Press the power button, the power blue LED will light up.
2. Press the Timer button to set the length of operation time. The numerical panel will display the operation time. When power is first turned on, the default setting is 80 minutes. The timer settings from 10 to 80 minutes in 10-minute increments.
3. Try to set the operation time by the size of the area to be cleaned in order to prevent overuse of the battery and shortening its lifespan.
4. When the battery is low, the Low Battery light will blink red.
5. In the following situations, the error light will light up: over charging battery, overloaded motor, and no traction for more than three consecutive seconds.

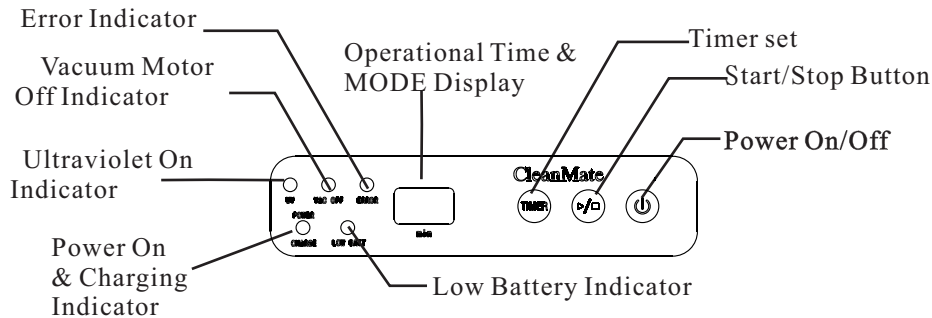

LED and Audible Indicator

Audible Indication	
Status	Description
Long Beep once followed by one Brief Beep	Times up (when the cleaning timer was set) Battery Low, cleaning function off
Long Beep once	Error
Brief Beep three times	Fully charged
Brief Beep three times and One long Beep	Fully charged and start vacuuming again (when the docking station is set that after fully charged, QQ-2 Plus will go out to vacuum again)

LED Indication

Color of LED Lights	Description
Green	Steady - Vacuum Function off
Red	Blinking - Battery Low
	Steady - Error
Blue	Steady - Fully Charged / Power On
	Blinking - Charging
Yellow	UV On

Remote Control Function

QQ2 Plus Series

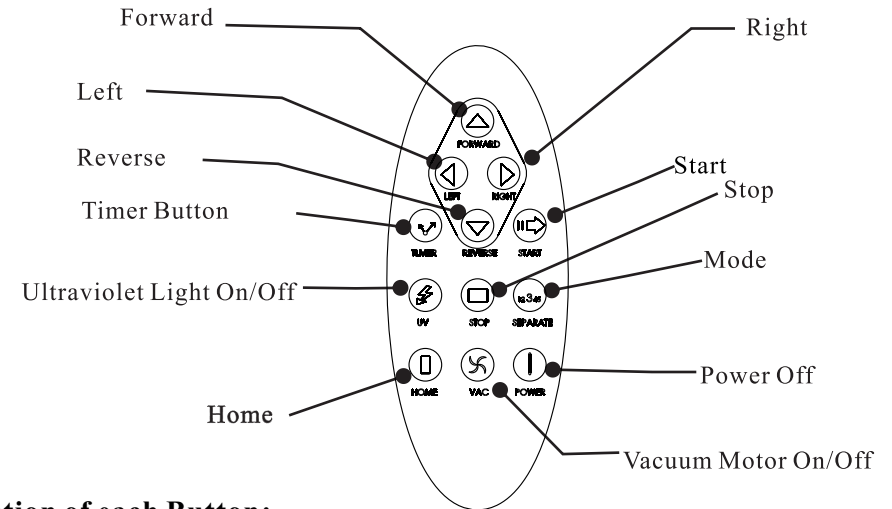

Function of each Button:

1. Start Button: Press the Start Button to begin the automatic cleaning of the room.
2. Stop Button: Press the Stop Button to stop the activity of the unit, and it will emit a long sound.
3. Timer button: Use this button to set the cleaning time of the QQ2 Plus.
4. Directional Buttons: Forward: when press forward QQ2 Plus will moving until user press forward button again or stop by obstacle.
Right, left and backward button: use these buttons to manually drive the unit to the right, left and backward.
5. Mode Button: Press this button to pick a specific cleaning pattern for the QQ2 Plus. By default the unit cleans in "Automatic" Mode (All 5 cleaning movements).
 - Press the "Mode" button once to make the unit clean in "Spiral" mode only. The timer will display "1" for one minute and then will show the cleaning time. When the QQ2 Plus comes in contact with any object while running in this mode, it will automatically stop its movement.
 - Press the "Mode" button again (Twice) to make the QQ2 Plus clean in "Special Bounce" mode only. The Timer will display "2" for one minute. Press the "Mode" button again (Three times) to make the unit run in "Along Wall" mode only. The Timer will display "3" for one minute.
 - Press the "Mode" button again (Four times) to make the unit run in "S Shape" mode only. The timer will display "4" for one minute.
 - Press the "Mode" button again (5 times) to make the unit run in "Polygonal Spiral" mode only. The Timer display will show "5" for one minute.

Remote Control Function QQ2 Plus Series

- Press the "Mode" button again (6 times) to return to "Automatic" mode (all 5 cleaning patterns). The Timer display will show "A" for one minute.
- 6. UV Button: Allows you to turn On and Off the ultraviolet light as needed.
- 7. Vacuum Motor Off Button: Press this button to control the On/Off of the vacuum motor.
- 8. Home Button: Use this Button to make QQ2 Plus go back to the charging base.
- 9. Power Off Button: to power Off QQ2 Plus manually by pressing power Off Button.

Battery Installation and Removal QQ2 Plus Series

1. Use two hand fingers to press the tabs at the front of the battery cover. Lift up the battery cover by these tabs as shown in Illustration 1.
2. Make sure the battery is inserted in the correct orientation by aligning the silver strips on the battery with the metal tabs in the battery compartment. Battery lifting band should face up after battery is installed. See Illustration 2.
3. Close the battery cover by first inserting the tabs into the slots at the back of the unit, and then pressing down on the front side of the battery cover until the plastic tabs click in place. Please see Illustration 3.

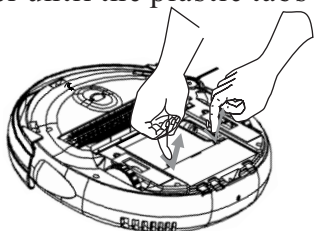

Illustration 1

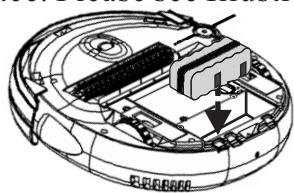

Illustration 2

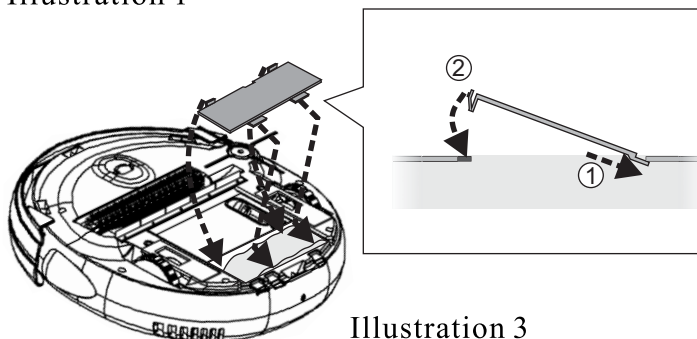
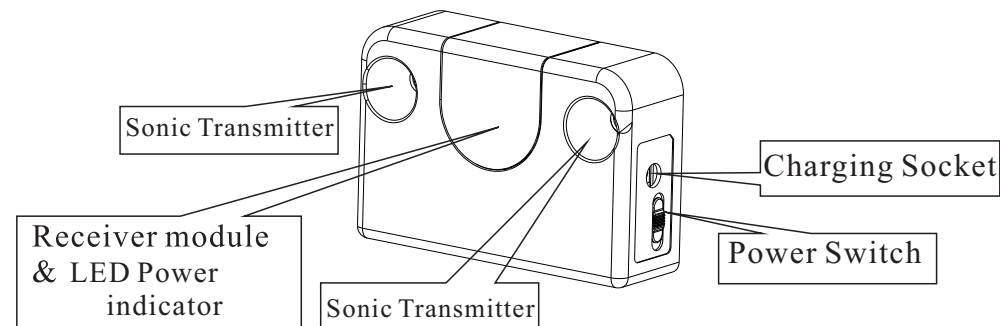

Illustration 3

Sonic Wall Setup

QQ2 Plus II

The Sonic Wall only works with **CleanMates that have the Sonic Wall Sensor on their bumper** (refer to diagram on page 5). It will create an invisible barrier that the CleanMate will not cross. This way, users can easily confine the CleanMate to one room or certain area to improve cleaning efficiency.



Instructions:

1. This CleanMate Sonic Wall is powered by 2 AA batteries. Make sure to install the included AA rechargeable batteries in correct polarity.
2. To turn on the Sonic Wall, slide the power switch to position "1".
3. For best effect, put the Sonic Wall on the other side of the door (see picture below) when you want to confine it in certain area. The CleanMate unit will detect the ultrasonic barrier from the Sonic Wall and not cross the invisible barrier line.
4. The effective distance of the Sonic Wall barrier is about 10 ft long.
5. To turn off the Sonic Wall, slide the power switch to position "0" to save battery power.
6. The LED power indicator on Sonic Wall will start blinking when its battery power is low. User can charge the Sonic Wall battery using the same CleanMate charger (item No. 5 on page 4) by plugging it into the charging socket on Sonic Wall.

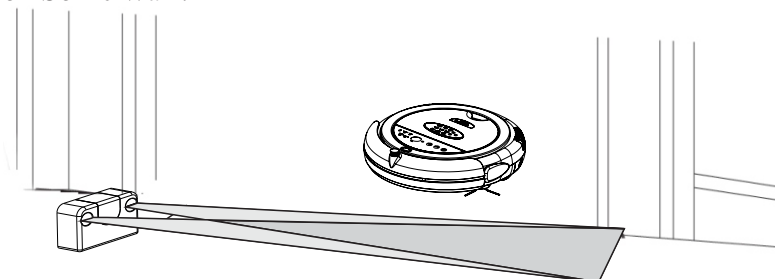

When CleanMate detects the ultrasonic signals from Sonic Wall, it will turn around and head to another direction.

Self Charging Home Base QQ2 Plus Series

Preparations

1. Find a proper place (we recommend a hard surface floor) to put the Self-Charging Home Base in the room. Leave about 20 inch (50 cm) clearance around the Home Base.
2. Connect the battery charger to the power input socket on the back of home base first. Then, place the metal plate of home base against the wall. Don't leave loose wire around the wall. Finally, plug battery charger to AC power outlet on the wall.
3. Make sure the LCD display on the Home Base is on. This means that the Home Base has been powered on, and it is ready to charge the QQ2 Plus

WALL OUTLET

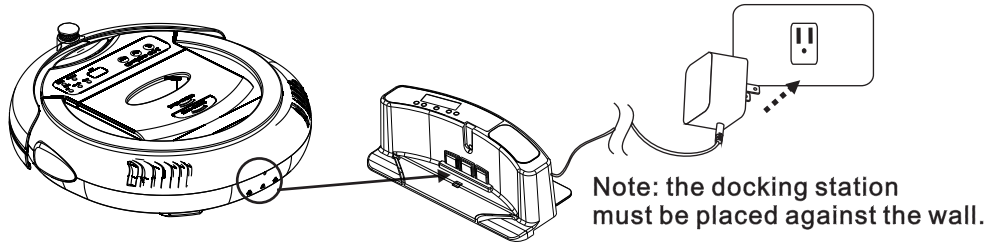

Testing the Home Base

1. Put the QQ2 Plus on the floor close to the Self-Charging Base and turn it on. Now press the "HOME" key on remote control. The QQ2 Plus should return to the Home Base automatically for self-charging.
2. Make necessary adjustment to the Home Base if the QQ2 Plus can not dock on the Home Base properly.

Battery Charging Methods

1. When its battery is running low, or after it has finished the cleaning job, QQ2 Plus will try to automatically return to the Home Base to re-charge itself. In case the QQ2 Plus is unable to find the Home Base before battery power is depleted, you can always charge it manually.
2. When you charge the QQ2 Plus manually, the battery will be charged no matter if the QQ2 Plus is on or off. Make sure to connect the charger to the CleanMate first and then plug it to the AC outlet on the wall. See the following diagram.

WALL OUTLET

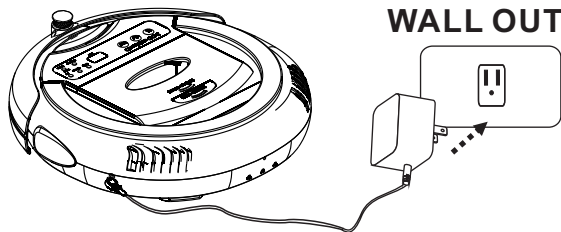

Scheduler Operations QQ2 Plus Series

With the help of scheduler on QQ2 Plus, user has the freedom to set up the cleaning time according to pre-programmed schedule. On this preset cleaning time, QQ2 Plus will start the cleaning session automatically. User can program it to start cleaning job at the same time on every day, or on any day of week user choose.

The scheduler LCD panel is located on the top of the QQ2 Plus self-charging base unit. User needs to plug the AC adapter into QQ2 Plus self-charging base, and power up the scheduler before setting up the clock and cleaning times.

1. Illustration of QQ2 Plus Scheduler LCD Panel

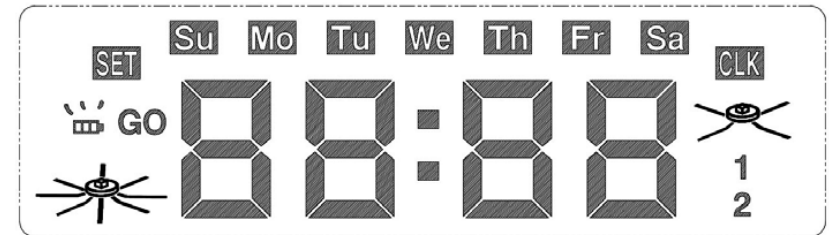

SET



Hr



Min



Wk



GO

- SET (on left side of LCD panel) sign is displayed when user set clock or cleaning schedule
- Week display (top of LCD panel): Each week day display will be shown as "Su", "Mo", "Tu", "We", "Th", "Fr" and "Sa".
- CLK (Right side of LCD panel) is displayed in Clock-setting mode
- GO (Left side of LCD panel), Battery and Brush icon on the left panel show that the cleaning will start once the battery is fully charged.
- Brush Icon on the right side of LCD panel is displayed when scheduled cleaning time has been set up and it is ready to start cleaning based on preset schedule.
- Clock digit display is in middle of LCD panel.

2. Scheduler Setting Operations

Setting the Clock

2.1 Once powered on, the scheduler will enter Clock Display Mode and display initial default setting of Sunday 00:00 (in 24 hours time format)

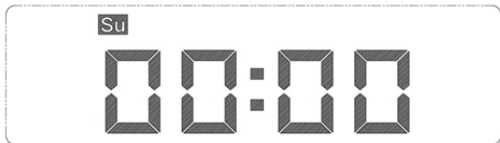

2.2 Press "SET" to set up the clock time (enter Clock-setting mode and display SET and CLK icon). Time and week will start blinking. Press "Hr", "Min" or "Wk" to set the correct time and week day. The display value will increase by "1" with each press, and the number will change rapidly if you hold the button. The clock will be set and display will become steady (SET and CLK disappear) if there is no key input for one minute (idling or no action).



Setting the Cleaning Schedule

User can schedule the QQ2 Plus unit to clean on any day of the week, up to 7 days per week (one cleaning time per day and same cleaning time on each day).

2.3 Press "SET" again to enter Scheduler Mode. Time and week will start blinking. Press "Hr", "Min" or "Wk" to set the cleaning schedule. The display value will increase by "1" with each press, and the number will change rapidly if user hold the button.

When user set hours and minutes, the cleaning time will not be scheduled if user select the bar ("- " sign as shown below) instead of a numeric digit.

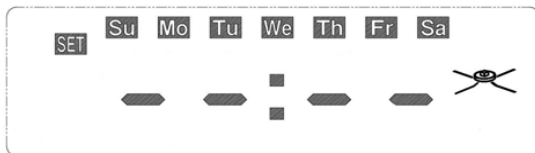

After cleaning time is set, you can choose to schedule the cleaning time on any day in a week. The initial default setting is to clean on everyday. Press "Wk", then the scheduler will highlight all 7 days of the week, which means the QQ2 Plus will start automatic cleaning once a day, 7 days a week (at same cleaning time).

If user wants to choose a particular day (or days) in a week to perform the cleaning job, then press "Wk" again. User will see "Su" start blinking. Press "Wk" one more time within 5 seconds if user wants to select Sunday, and user will see "Su" turns into steady state to confirm user setting. If user wants to select a day other than Sunday, just wait for more than 5 seconds and user will see "Mo" or other days of the week. To select a particular cleaning day, just press "Wk" within 5 seconds after user sees it blinking to confirm. If user want to skip a day, wait for more than 5 seconds (without pressing "Wk" key), and it will start display the next week day for user to choose.

2.4 When cleaning schedule set up is complete, press "SET" again and the scheduler will return to the Clock display Mode.

Example 1 (LCD display with brush icon) - Scheduler is set up to perform a preset cleaning job and current time is Monday 8:10AM.

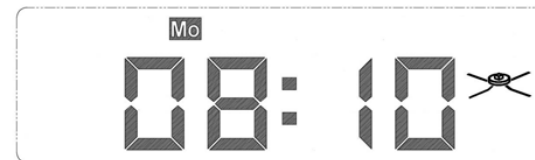

Example 2 (LCD display with no brush icon) - Scheduler has NOT been set up to do any preset cleaning job and current time is Monday 8:10AM.

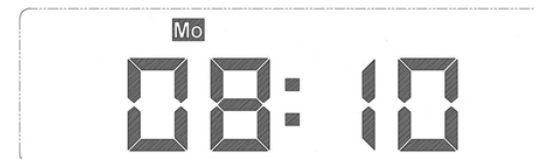

3. How to Delete a Preset Cleaning Schedule

When scheduler displays clock time (at Clock Display Mode), press "SET" once and it will enter Clock-setting Mode. Press "SET" again, it will enter Scheduler Mode. When user set hours and minutes, the cleaning will be deleted if user select the bar ("- " sign as shown below) instead of a numeric digit.

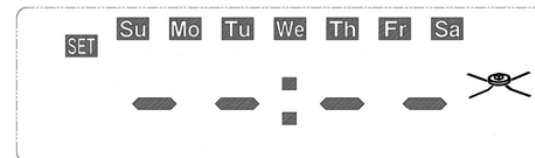

4. How to Display a Preset Cleaning Schedule

When scheduler displays clock time (at Clock display Mode), press "SET" once it will enter Clock-setting Mode. Press "SET" again, it enters Scheduler Mode and it

5. Start Cleaning Automatically Right After Battery is Fully Charged

Press “GO” (for about 1 second) on the self-charging base, and you will see Battery, Brush and GO icons turned on (as shown below) on the left side of LCD panel. This indicates that the QQ2 Plus vacuum will automatically start a cleaning cycle right after the battery is fully charged.

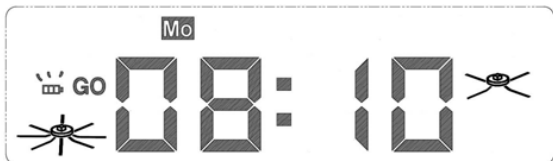

Press the “GO” button again to turn this function off. **Note: QQ2 Plus vacuum cleaner will only run one cleaning cycle after “GO” button is selected.**

6. How to Start Cleaning Right Away

If you hold down “GO” button for 5 seconds, the QQ2 Plus on the self-charging base will leave the base and begin the cleaning right away, no matter whether the battery has been charged in full or not. This function works the same way as you push “START” button on the remote control on page 7.

7. How to Start Cleaning with Remote Control

When the QQ2 Plus is being charging on the self-charging base, you can direct the QQ2 Plus to begin cleaning when you press “START” button on your remote control.

Side-brush Installation and Removal

- To remove the Side-brush, use a Philips head screwdriver to remove the screw in the center of the Side-brush by turning it counter-clockwise.
- To install the Side-brush, place the Philips head screw through the center hole of the Side-brush, and align the screw with the hole in the slot for the Side-brush. Attach the screw by turning it in a clockwise direction, until the screw is firmly in place.

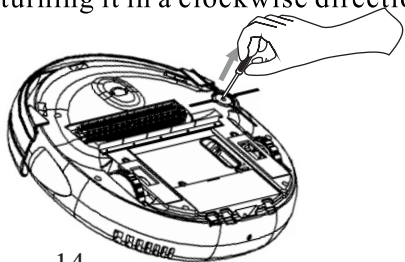

Roller Brush Installation and Removal

Ensure that the power of the CleanMate is 'Off', and turn the CleanMate upside down so that the bottom of the unit is facing you.

Align the slotted end of the roller brush with the slot in the flexible insert in the right side of the roller brush compartment (near the side brush) and press it into place.

Push the free end of the roller brush down into the roller brush compartment, and align the free end with the brush holder on the left side of the compartment. Slide the roller brush to the left to secure it in place.

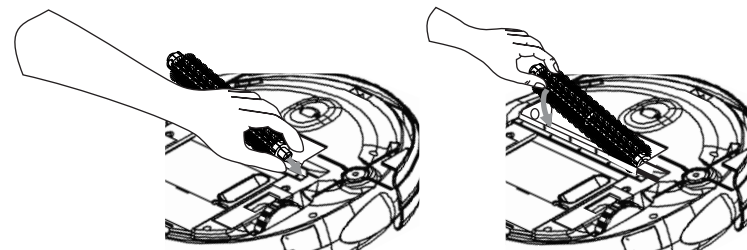

Fragrance Installation and Removal

This Intelligent Automatic Vacuum has a compartment built into it for adding fragrance to the air as the unit cleans. Any solid scent packet, insert, or dryer sheet can be used.

DO NOT use any type of Liquid or Oil Fragrance with this unit.

1. Press the "Dust Bin Release Button" to release the dust bin cover.

See the arrow in Illustration 1.

2. Remove the dust bin cover as shown in Illustration 2.

3. Remove the dust bin from its compartment as shown in Illustration 3

4. Place the fragrance pack into the compartment as shown in Illustration 4.

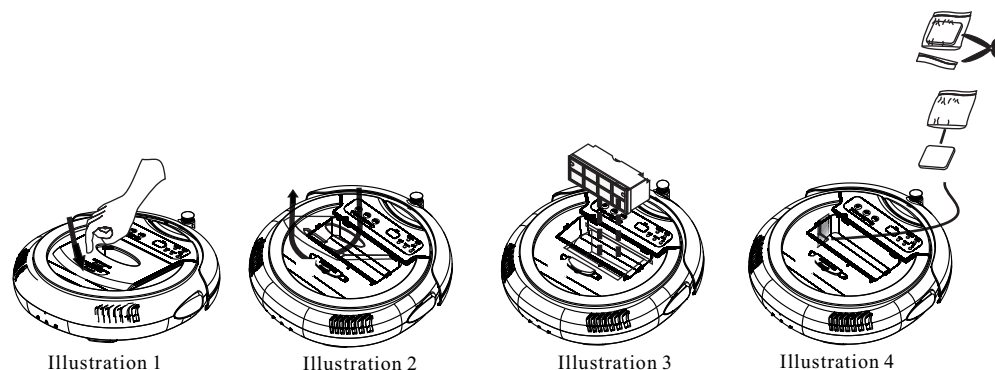

Illustration 1

Illustration 2

Illustration 3

Illustration 4

1. Make sure you have completely charged the battery before using it for the first time.
2. Room preparation:
 - A. Pick up all large items off of the floor that could get stuck in the brushes or the vacuum intake.
 - B. Pick up/hide all cords that could get tangled in the unit.
 - C. Move all items that could be easily knocked over.
 - D. Roll under loose edges of rugs with any type of stringy fringe.
3. DO NOT use the QQ2 Plus on plush or long pile carpet or rugs.
4. When using the CleanMate in a room for the first time, watch how it operates in the room. Watch for areas that the unit has troubles operating in, and either block these areas of the room or move objects around so that the unit can clean effectively and not get stuck or hung up before it is able to clean the entire room.

Starting Operation

1. Clean out the dust bin before use.
2. Place the QQ2 Plus on the floor in a relatively open space near the middle of the room to be cleaned.
3. Press the power button on the main unit to turn it on.
4. Set the timer of the unit to the desired cleaning time by pressing the Timer button on the remote control.
For Reference: Use 10 minutes of cleaning time for Every 5-7M² (54-72ft²) of floor space. Cleaning time may vary depending on the type of floor being cleaned.
5. Press the Start button on the control panel or the remote control. After a short delay, the QQ2 Plus will begin to automatically clean the floor.
6. At the end of the cleaning cycle, the QQ2 Plus will emit a long beep and will turn off the vacuum motor and start to search for docking station.
If the low battery light on the unit is blinking, then the battery is low and QQ2 Plus needs to be recharged before it can be used again.

Stopping Operation

- Press the Start or Power button on the control panel of the unit or press the Stop button on the remote control.

Cleaning and Maintenance

The operation and maintenance of the CleanMate is very simple. To maintain top performance of the unit, it is recommended that you follow a routine cleaning and maintenance schedule after each use.

1. Make sure to clean empty the Dust Bin and to brush off the Air Filter after every cleaning cycle.
2. Make sure that the vacuum intake is free of any debris and obstacles.
3. Make sure that the bristles of the Side Brush are free and not tangled with hair, etc.
4. Make sure that there is not a lot of hair, string, etc caught up in the Roller Brush.
5. Remove and clean out the Roller Brush.
6. Make sure that there is nothing blocking the air ventilation exits on the top of the unit.

Cleaning Dust Bin and Air Filter

1. Make sure the power of the unit is 'Off'.
2. Press the Dust Bin Open Button. (See Illustration 1)
3. Remove the Dust Bin Cover. (See Illustration 2)
4. Remove the Dust Bin from its compartment by placing your finger(s) in the groove near the front of the CleanMate, and on the tab at the center of the air filter. Squeeze to disengage the tab, and then lift the Dust Bin straight out of its compartment. (Illustration 3)
5. Remove the Air Filter from the Dust Bin by firmly holding the Dust Bin in one hand, and pulling the Air Filter out by the tabs on the Air Filter. (Illustration 4)
6. Empty the contents of the Dust Bin into a trash can. (Illustration 5)
 - Rinse the Dust Bin with water if needed. (Illustration 6)
 - Let the Dust Bin completely dry before using it again.
7. Using the provided Hand Brush to brush debris off the Air Filter. (Illustration 7)
 - The Air Filter can be rinsed out with water
 - Make sure the Air Filter is completely dry before using it again.
8. DO NOT clean the Dust Bin or the Air Filter in a Clothes Washing Machine or a Dish Washing Machine.

9. While the Dust Bin is removed from its compartment, turn the unit over, and using the Hand Brush to brush any excess dust that might have accumulated in the compartment into a trash can.
10. Once the Dust Bin and Air filter are completely dry, put the Air Filter back in place on the Dust Bin. (Illustration 8) Then put the assembled Dust Bin and Air Filter back into the Dust Bin compartment, with the air filter pointed away from the control panel.
11. Put the Dust Bin Cover back in place by first inserting the tabs on the cover into the slots on the case of the unit, then press down firmly on the edges of the Dust Bin Cover until the Release Button clicks into place. (Illustration 10) Make sure the Dust Bin Cover is securely in place before operating the unit.

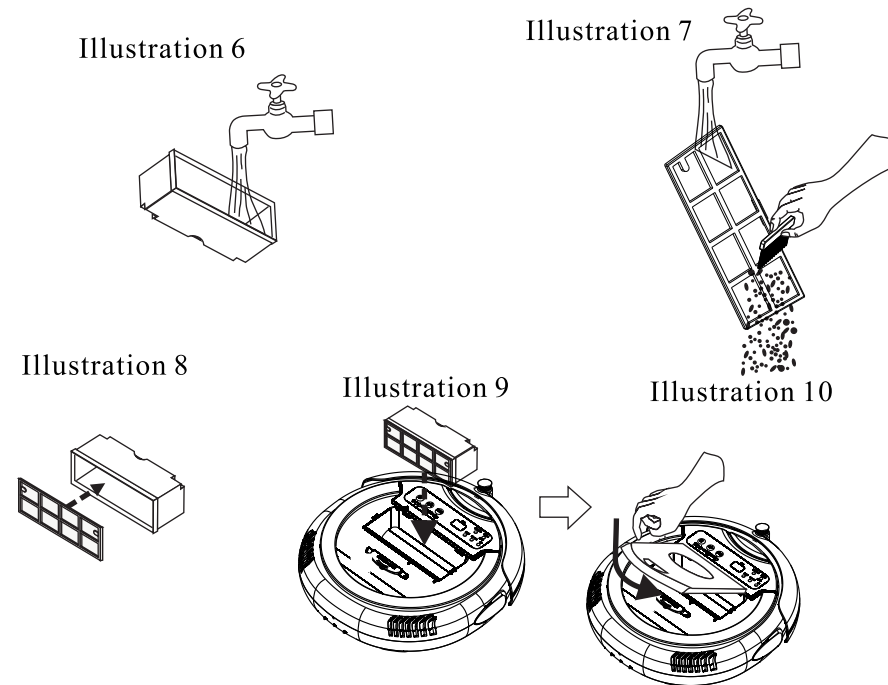
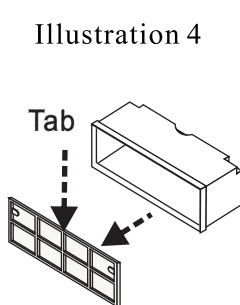
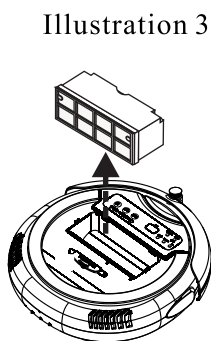
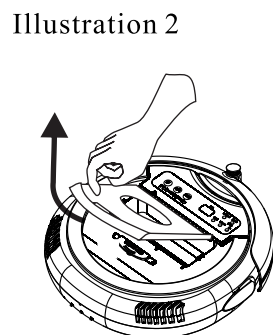
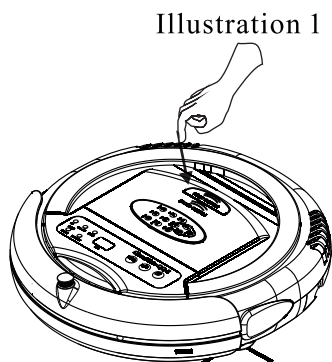

Cleaning the QQ2 Plus

Over time dust and dirt can accumulate in different areas of the unit, **DO NOT** use water to clean the unit. This is an electrical unit, and if any of the electric components get wet, the unit will no longer work, and could cause a short circuit and potentially harm someone. Use Canned Air, the Hand Brush provided with the unit, or a dry cloth to wipe away accumulated dust and dirt. After operating the machine for a period of time, dust and dirt will accumulate on the vacuum entry on the bottom of the QQ-2 Plus. Cleaning this area regularly will help ensure that the unit performs properly.

1. Make sure the power of the QQ-2 Plus is turned off.
2. Turn the unit upside-down, and brush any dust that has accumulated inside the vacuum entry as shown below. Shake the dust out into a trash can.

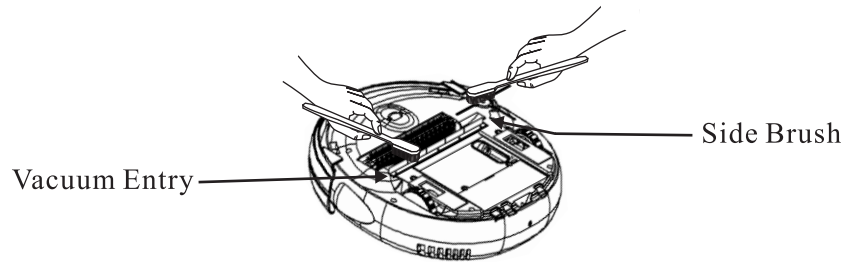

Cleaning the Roller Brush

Hair and other stringy items can get caught in the roller brush over time.

1. Make sure the power to the unit is turned off.
2. Turn the QQ-2 Plus upside-down and place it on a flat surface with the back of the unit facing you.
3. Remove the Roller Brush from its compartment by grabbing the left side of the Roller Brush, and sliding it toward the right until the left side of the brush is free.
4. Lift the free end of the Roller Brush out of the compartment, then slide the Roller Brush to the left, freeing it from the flexible insert.
5. Remove any hair, string or other debris from the roller brush to ensure proper performance of the unit.
6. With the Roller Brush removed, loosen any dirt that has accumulated in the Roller Brush compartment with a brush, then dump the dirt into a trash can.
7. Re-install the roller brush following the steps outlined in Roller Brush Installation and Removal Section.

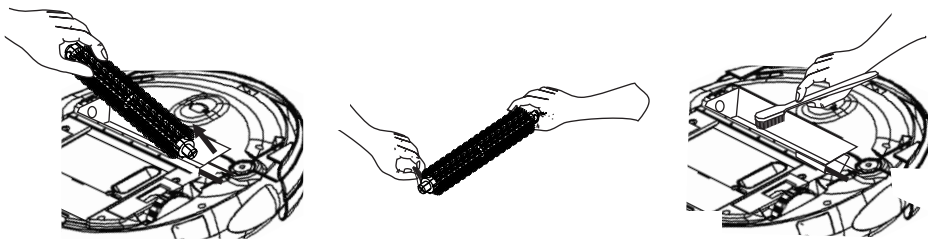

Tip#1: Clear the area where the QQ-2 Plus is to clean of any items can be easily knocked over, or caught with the Roller Brush or Side Brush.



In the area where the QQ-2 Plus operates, it might knock over items such as vases, glasses, or lamps.

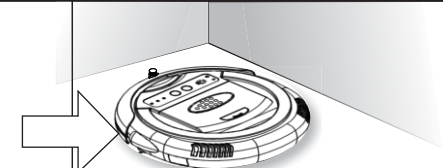

In order to provide the QQ-2 Plus a space for fast and safe cleaning, please remove small items from the area before operating.

Tip#2 Adjust the distance between furniture, walls and other objects to be at least 36 cm (14 in).

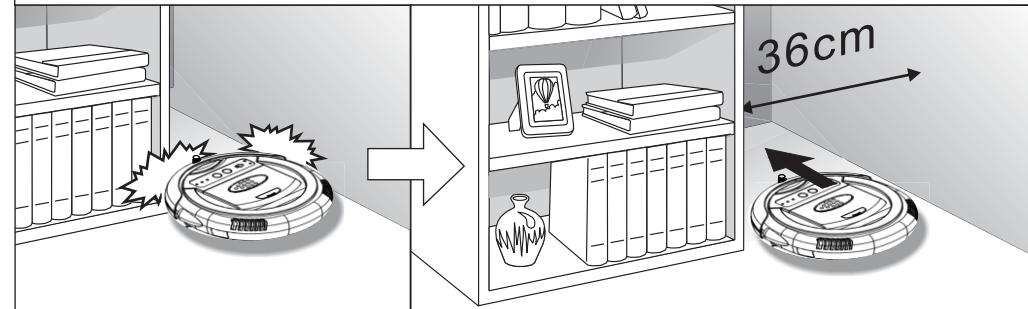

Tip#3 Do not let the loose edges of rugs, drapes, table cloths, etc. get caught in the QQ-2 Plus. Roll under the loose edges of rugs and make sure that any table cloths, drapes, bedding etc. do not hang down to the floor.

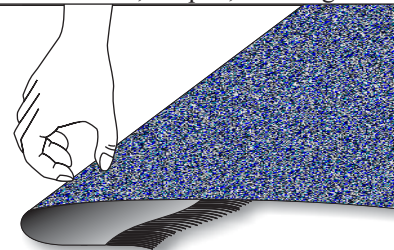

When the QQ-2 Plus is cleaning rugs, fold under the edges of the rug.

Remove plastic bags and leftover long-shaped garbage

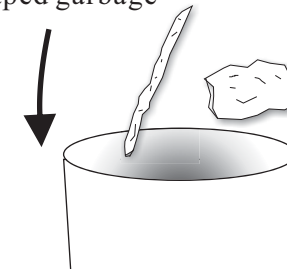

Useful Tips

QQ2 Plus Series

Tip#4 Fixing jams: Objects can get caught in the Roller Brush and prevent it from working properly. Immediately turn the unit off, clear the object causing the jam, and resume normal use.

When something is jammed inside the QQ-2 Plus, it will emit a beeping sound.

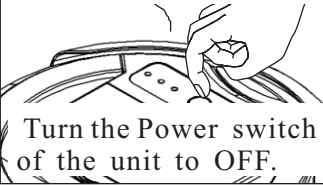

Turn the Power switch of the unit to OFF.

Turn the QQ-2 Plus upside-down, and remove the objects.

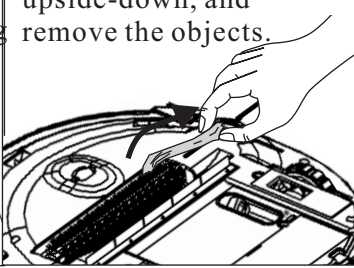

Clean the vacuum entry.

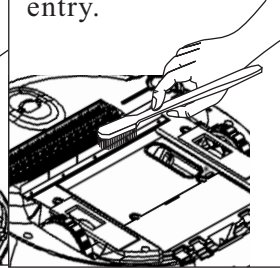

Tip#5 Block areas where the QQ-2 Plus could get stuck by placing objects in the way so that the QQ-2 Plus does not go into these areas.

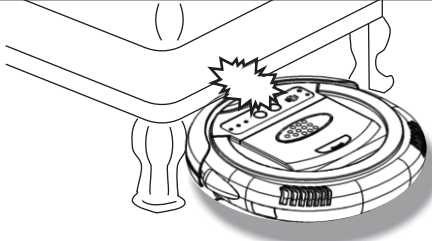

The space under some furniture may not be high enough for the QQ-2 Plus to get underneath.

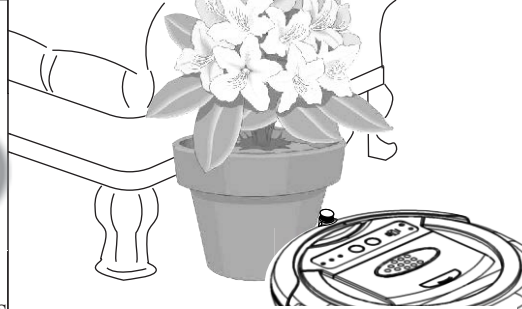

Use a potted plant to block the QQ-2 Plus and prevent it from going these places.

Tip#6 Aim the remote control at the sensor on the front of the QQ-2 Plus. Anything blocking the signal will affect the performance of the remote control.

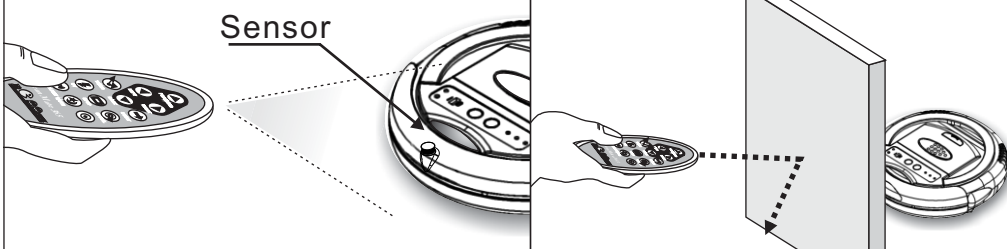

Specification

QQ2 Plus Series

Specification

Item	Description
Suction Power Speed	4.5 meters per second, 9000 rpm vacuum motor
Fast adapter/charger	Output: 20Vdc 1000mA Input: 100 - 240V 50 - 60 Hz
Battery	Ni-MH 14.4V, 2.5Ah Rechargeable, 3.5 hours of charging time
Noise	80dB at distance of 20 cm
Life time of UV ray	6000 hours continuously
Capacity of dust bin	0.3 liter
Moving speed of machine	16.5 ~ 18.5 cm/sec
Remote control	Infrared light with more than 3 meters controlling range, 3V button Lithium battery CR2032
Types of movement	5 types: Spiral, Special Bounce, Along Wall, S shape, Polygonal Spiral
Dimension	36cm(Diameter)x 9cm (H) or 14inch (diameter) x 3.5 inch (H)
Weight	3kg

Troubleshooting

QQ2 Plus Series

This troubleshooting guides cover some CleanMate problems that you might have.

If problem persists, please contact your local warranty provider or www.infinuvo.com for further assistance.

The repairs that marked * needs to be done by qualified service personal.

Problem Symptoms	Possible Cause	Things to do
Both ERROR & LOW BATT indicators are on	Battery installation problem	Make sure battery has good contact with charging stripes, and battery lifting band faces up.
	Battery malfunction	Charge battery manually for 2 days (see Page 10) or replace battery.
ERROR indicator on	CleanMate is lifted off ground over 3 seconds while running	Put the CleanMate back on to the ground.
	CleanMate is stuck	Remove deris & hairs from brushes and wheels
LOW BATT indicator on	Battery power is low	Recharge the CleanMate battery
Can not power on the home charging base	Malfunction charging base	Replace the charging base
Home base LCD display malfunction (scheduler version only)	Malfunction LCD display on home base	Replace the LCD on charging base. *
Can not dock on the home charging base	Malfunction charging base	Replace the charging base *
	Malfunction sensor on CleanMate unit	Repair the CleanMate main unit *
Fall down steps or stairs	Malfunction cliff sensors	Repair the CleanMate main unit *
Always turning in circles to left	Left wheel stuck or malfunction	Clean or replace left wheel
Always turning in circles to right	Right wheel stuck or malfunction	Clean or replace right wheel
Always going backwards	Bumper protection pads not removed	Remove bumper protection pads
	Malfunction front bumper sensor	Clean or replace front bumper sensor *
	Malfunction control board	Replace control board *
Main roller brush stuck	Too much debris & hairs on brush	Remove debris & hairs from roller brush. Replace the roller brush if necessary
	Malfunction brush motor	Replace brush motor *
Side brush stuck	Too much debris & hairs on brush	Remove debris & hairs from side brush. Replace the side brush if necessary
	Malfunction brush motor	Replace brush motor *
Remote control does not work	Remote control battery bad	Replace the button battery in the remote control .
	Remote control defective	Replace the remote control

Warranty Policy

QQ2 Plus Series

Please fill in your warranty card completely and submit it to your local customer service center.

Infinuvo provides you, as the owner of this Infinuvo product, with the following Limited Warranty Policy.

One year Product Warranty:

Infinuvo warrants to the original purchaser of this Infinuvo product that the product is free from defects in original materials and workmanship for a period of up to one year from the date of initial purchase. This warranty is only valid if the product has been properly installed and is used in the way for which it is intended, and has received only factory-authorized repairs, servicing or alterations.

Under-warranty products that meet these conditions and that function improperly will be repaired or replaced, at the discretion of Infinuvo.

Six months Battery Warranty:

Infinuvo warrants to the original purchaser of this Infinuvo product that the original batteries contained within this product will function for a period of six months. This warranty is only valid if the product has been properly installed and is used in the way of which it is intended, and has received only factory-authorized repairs, servicing, or alterations.

Under-warranty batteries that meet these conditions and that function improperly will be repaired or replaced, at the discretion of Infinuvo.

These warranties contain the sole express warranty of Infinuvo, which makes no other warranties, expressed or implied. These warranties are made in lieu of any implied warranties of merchantability or fitness for a particular purpose. These warranties give you specific legal rights. You may also have other rights, which vary from state to state.

WHEN YOU RETURN A CLEANMATE PRODUCT OR BATTERY UNDER THIS WARRANTY, you must first obtain an RMA number by calling your local customer service center or www.infinuvo.com. Infinuvo reserves the right to request that you submit a letter describing the circumstances under which the problem occurred and that you submit invoice and any other supporting evidence and documentation.