

bernette

SWISS DESIGN



COVERSTITCH CHAINSTITCH

**WORKBOOK #2 – COVERSTITCH,
CHAINSTITCH, 5-THREAD STITCH**

For bernette Overlockers: b 42, b 48



**MASTERY
BOOK
SERIES**

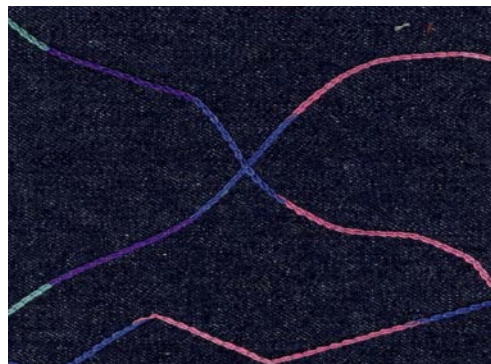

TABLE OF CONTENTS

TABLE OF CONTENTS.....2
 INTRODUCTION3
 REFERENCE - OVERLOCKER NEEDLES.....4
 REFERENCE - OVERLOCKER THREADS.....5
 3-THREAD OVERLOCK & CHAIN NARROW b48 ONLY6
 MACHINE CONVERSION (b48 ONLY)7
 BEGIN/END COVER/CHAINSTITCH.....8
 4-THREAD/3-NEEDLE COVERSTITCH9
 3-THREAD WIDE COVERSTITCH 10
 3-THREAD NARROW COVERSTITCH 11
 CHAINSTITCH 12
 SUPPLIES..... 13



The information in this workbook applies to the Bernette Overlocker Machines models shown above.

Note: Some exercises apply only to certain models equipped with the feature being highlighted.

INTRODUCTION

Congratulations on the purchase of your new bernette overlocker. Learning to use your new machine to its fullest capabilities will let you enjoy your machine for many years. Understanding your machine's features and learning its navigation will maximize your creativity. While you will be learning some basics, you'll also be learning some creative techniques, and we hope both will be inspirational.

Your overlocker will speed your sewing in many ways, letting you produce more in less time. The speed of the overlocker is faster than a sewing machine, and because it performs several operations (trimming, seaming, and overcasting) at the same time, your project is finished faster and will produce neater and more professional results.

Even though the workings of the overlocker may appear be more complex than a sewing machine, it doesn't take long to learn the basics. The stitching exercises in this workbook use four, three, and two thread stitch formations.

Once you have completed the exercises designated for your bernette overlock machine, attach the sewn samples to the indicated pages, insert the pages into plastic page protectors and store them in a 3-ring binder. Use this workbook as a reference tool in the future as you learn to use your overlocker in new ways.

For more information on the bernette line of sewing machines and overlockers, as well as sewing projects, visit:

www.mybernette.com

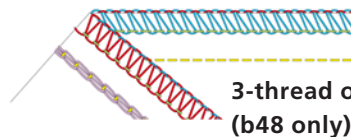

3-thread overlock with chainstitch (b48 only)

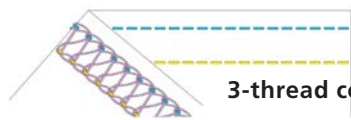

3-thread coverstitch-wide



2-thread chainstitch



Click here to watch additional YouTube tutorial videos about the b44 and b48.

REFERENCE - OVERLOCKER NEEDLES

bernette Overlocker Needles

Along with thread, needles are very important to stitch formation. Many mechanical problems and damage to fabrics can be traced to a bent, damaged, or incorrect size or type needle.

When selecting the correct needle, consider the following:

- Recommended needle system – ELx705. These needle are a flat shank industrial needle. A pack of these needles is included with the overlocker.
- Recommended sizes for your overlocker are 70/11, 80/12 and 90/14. Larger needles can interfere with looper movement and cause damage; smaller needles may not form the stitches correctly.
- Needle point – assures proper stitch formation; avoids fabric damage

Need to Know

- Always make sure needles are fully inserted as high as possible, with the flat side to the back. The left needle will appear to be slightly higher than the right needle.
- Do not pull or push fabric while sewing. This can result in needle breakage or damage.
- Do not use bent or damaged needles.
- The needle is the most inexpensive part in your sewing machine, but it is crucial for getting good results and keeping your machine running well.
- The selected thread should fit in the groove on the front of the needle. If it isn't protected by the groove, a needle with a larger groove should be used.

Tip: If one needle breaks, it is a good habit to change both needles. Keeping the needle size and type the same results in a better formed stitch.

Needle Size for Fabrics
 70 – shirt-weight
 80 – medium-weight
 90 – denim and twill

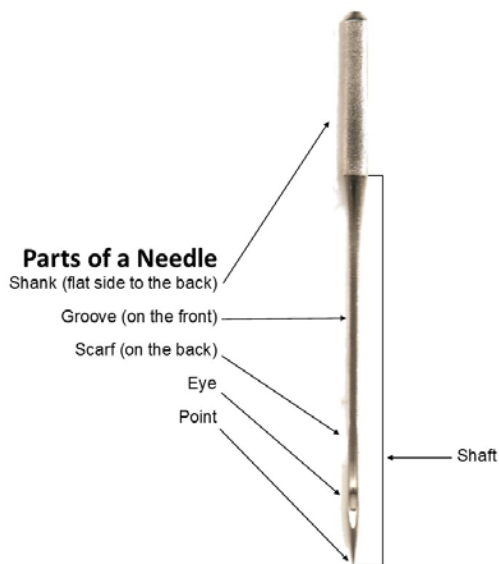

REFERENCE - OVERLOCKER THREADS

Overlocker Threads

Overlocker threads are usually polyester and are finer (lighter weight) than many sewing machine threads to avoid thread build-up and excessive bulk in seams. It is important that the thread is smooth and without variations in diameter as it needs to feed smoothly through many thread guides for good stitch formation.

You also want a good-quality thread – such as Mettler Seracor – that is not “fuzzy” and does not leave excessive lint in the lower part of your overlocker. Overlocker threads are sold on larger spools for economy and convenience; regular spools of thread may be used but will not last very long when forming overlock stitches. Along with overlocker thread, there are applications that call for specialty and decorative threads.





Listed below are some of these threads commonly used in the overlocker:

- Texturized Nylon Thread – such as YLI Woolly Nylon or Maxi-Lock Stretch—A very elastic thread with excellent coverage; perfect for rolled edges and knit seams. Available in solid and variegated colors, and metallics.
- Polyester Topstitching Thread – such as YLI Jeans Stitch & Mettler Cordonnet – this heavy thread is used for decorative stitching (flatlocked seams and overcast edges). Also nice for cover and chain stitching. Available in solid and variegated colors.
- Rayon Decorative Threads – such as YLI Pearl Crown Rayon & YLI Designer 6 – shiny threads for decorative applications. Pearl Crown Rayon is twisted, while Designer 6 is untwisted. Available in solid and variegated colors.
- Metallic Decorative Threads – such as YLI Candlelight – adds a bit of glitz to seams and edgings.
- Decorative Sewing Threads – sewing machine threads can also be used in the overlocker, and are particularly effective when several are used together as one thread.



3-THREAD OVERLOCK & CHAIN NARROW

b48 ONLY

-  Medium weight denim, 6" x 8"
-  80/12 ELx705
-  5 Spools Serger Thread (B, R, G, Y, P)
-  3-thread/2-needle coverstitch
-  Standard Foot

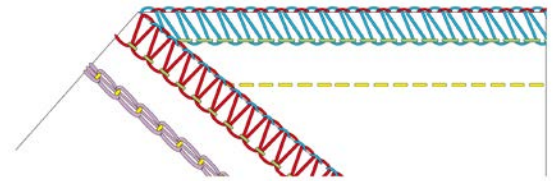

b48 ONLY:

The 5-thread stitch is a safety stitch made up of combined 3-thread overlock and double chainstitch. A wide seam is formed by using the left needle, or a narrow seam is formed by using the right needle. Overlock and seaming can be done in one operation. This stitch is generally used on non-stretch fabrics.

1. Thread the overlocker for a 3-thread overlock and chain using the thread colors to match the color-coded threading path on the machine and diagram in the user manual. Adjust all thread settings as indicated in the chart below. The mechanics of the machine will be set as if to do a regular overlock. Use the right overlock needle position and the center coverstitch needle position.
2. Fold the fabric in half to 3" x 8".
3. To begin stitching, trim the edge of the fabric fold at 1/4" approximately 1" long. Then lift the presser foot and slide the fabric under the presser foot and underneath the needles. Release the presser foot and begin stitching, trimming the fold away. NOTE: Trimming a minimum 1/4" will result in a cleaner edge finish.
4. Stitch to the end of the fabric. Continue stitching off the fabric until you have a 3-4" thread chain. Cut thread chain with scissors

								MACHINE SETUP				
LEFT COVERSTITCH NEEDLE	CENTER COVERSTITCH NEEDLE	RIGHT COVERSTITCH NEEDLE	LEFT NEEDLE	RIGHT NEEDLE	UPPER LOOPER (B)	LOWER LOOPER (R)	CHAINSTITCH LOOPER (P)	STITCH LENGTH	CUTTING WIDTH	DIFFERENTIAL FEED	ROLLED HEM LEVER	PRESSER FOOT PRESSURE
-	2	-		4.5	4.5	4	5.5	3.5	6	1	N	NORMAL

MACHINE CONVERSION (b48 ONLY)

 80/12 ELx705

 4 Spools Serger Thread (B, G, Y, P)

 Standard Foot

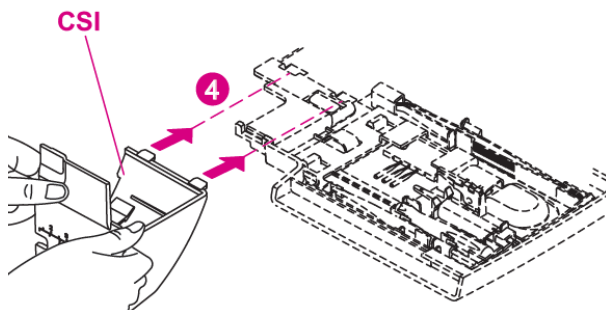
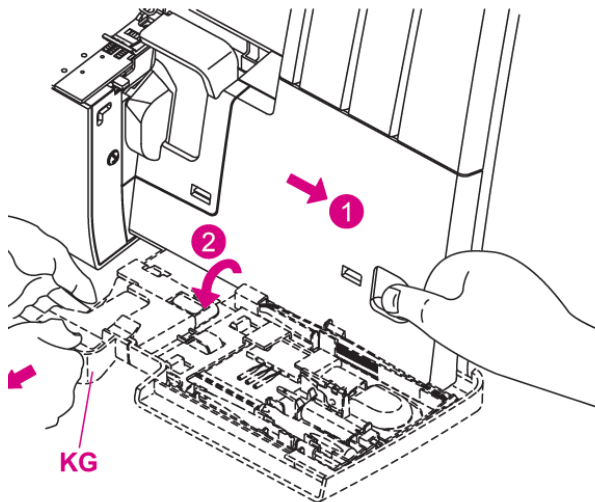
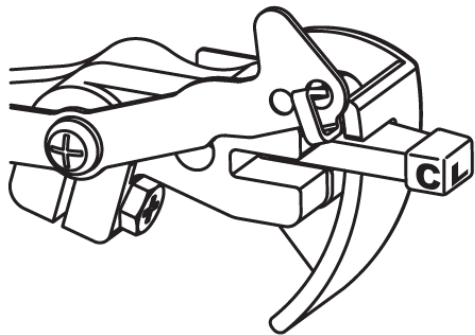

Converting the b48 from overlock to coverstitch and back requires some mechanical machine set-up steps. When doing this, make sure to turn the power to the machine off.

1. Open the looper cover.
2. Move the knife into a non-working position. Pull the knife holder to the right and rotate the holder counter clockwise until the knife clicks into a locked position.
3. Disengage the upper looper by turning the handwheel until the drive shaft is in the correct position to lock the clutch button for cover/chainstitch showing the letter "C".
4. Set the rolled hem selection lever to the "R" position.
5. Remove the knife cover and install the seam guide plate in the looper door.
6. Remove the needles from the overlock position.
7. Install the needles into the coverstitch position(s).
8. Thread the machine for coverstitch as shown in the diagram and machine manual.
9. Close the looper cover.

BEGIN/END COVER/CHAINSTITCH

 80/12 ELx705

 4 Spools Serger Thread (B, R, G, Y)

 Standard Foot



At START of sewing:





1. Raise the presser foot.
2. Place fabric under the presser foot behind the needles and lower the presser foot.
3. Begin sewing with fabric under the foot. When you start sewing in the middle of the fabric, place the fabric under the needles at the desired point of sewing.

At END of sewing:

1. Stop sewing at the edge of the fabric (or if sewing in a tubular shape, sew over a few stitches at the beginning and stop).
2. Raise the needles to the highest position.
3. Raise the presser foot.
4. Using tweezers, move from behind the needle threads (over the fabric) and pull the threads from under the foot out to the left of the machine. Trim the thread.
5. Remove the fabric from under the foot toward the back and left of the machine. The thread tails will release and move to the back of the fabric locking the stitch in place.
6. Trim the looper thread and keep the remaining thread tail to the back of the machine to prepare for the next stitching.

Tip: Avoid chaining off when sewing a coverstitch because the machine cannot maintain the stitch without fabric and it may cause problems with thread breaking or the machine coming unthreaded.

4-THREAD/3-NEEDLE COVERSTITCH



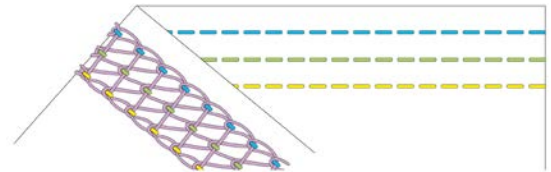

-  Sweatshirt knit, 4" x 8"
-  80/12 ELx705
-  4 Spools Serger Thread (B, R, G, Y, P)
-  4-thread/3-needle coverstitch
-  Standard Foot



1. Set the overlocker for a 4-thread/3-needle coverstitch. Adjust settings as directed below.
2. Fold the fabric under 1" with wrong sides together to create a hem and align the fabric under the presser foot, using the guidelines on the stitch plate. Place the fabric completely under the foot.
3. Stitch to the end of the fabric.
4. At the end of the stitching, carefully end and lock your stitch as described on Page 8.
5. Adjust settings as necessary; stitch a second row of coverstitch.

THREAD TENSION SETTING				MACHINE SETUP		
LEFT COVERSTITCH NEEDLE	CENTER COVERSTITCH NEEDLE	RIGHT COVERSTITCH NEEDLE	CHAINSTITCH LOOPER	STITCH LENGTH	DIFFERENTIAL FEED	PRESSER FOOT PRESSURE
3	6	6.5	4	3.5	1	NORMAL

3-THREAD WIDE COVERSTITCH



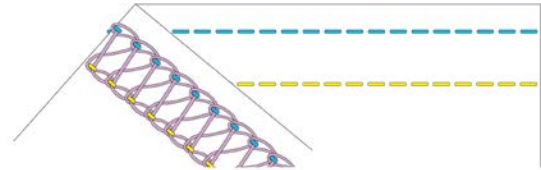

-  Medium weight cotton, 4" x 8"
-  80/12 ELx705
-  3 Spools Serger Thread (B, Y, P)
-  3-thread/2-needle coverstitch (wide)
-  Standard Foot



1. Set the overlocker for a wide 2-needle coverstitch using the left and the right needles (remove the center coverstitch needle and thread). Adjust settings as directed below.
2. Fold up a 2" hem along the 8" edge of the fabric. Glue stick or pin in place.
3. Using the markings on the stitch plate as a guide, place the fabric under the needles with the fold to the right of the presser foot, and with the right side of the fabric up and the hem/wrong side down.
4. Coverstitch the hem in place.

THREAD TENSION SETTING				MACHINE SETUP		
LEFT COVERSTITCH NEEDLE	CENTER COVERSTITCH NEEDLE	RIGHT COVERSTITCH NEEDLE	CHAINSTITCH LOOPER	STITCH LENGTH	DIFFERENTIAL FEED	PRESSER FOOT PRESSURE
4	-	6.5	4	3.5	1	NORMAL

3-THREAD NARROW COVERSTITCH



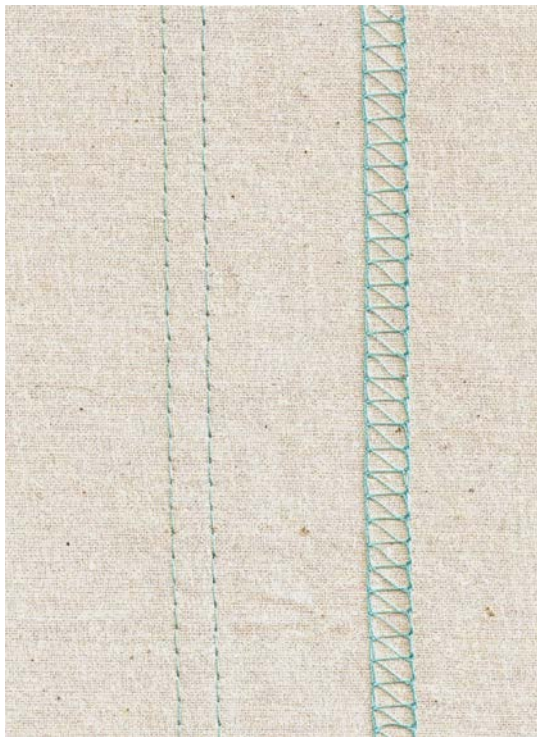
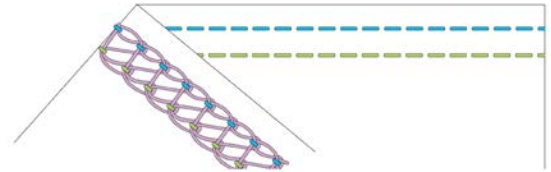

-  Jersey knit, 6" x 8"
-  80/12 ELx705
-  3 Cones Serger Thread (B, R, G, Y)
-  3-thread/2-needle coverstitch (wide)
-  Standard Foot



1. Set the overlocker for a narrow 2-needle coverstitch using the center and the right needles (remove the left needle and thread, then insert the center needle and thread). Adjust settings as directed below.
2. Fold the fabric under 1" to create a hem and align the fabric under the presser foot, use the guidelines on the stitch plate. Place the fabric completely under the foot.
3. Stitch to the end of the fabric.
4. At the end of the stitching carefully end and lock your stitch as described on Page 8.

THREAD TENSION SETTING				MACHINE SETUP		
LEFT COVERSTITCH NEEDLE	CENTER COVERSTITCH NEEDLE	RIGHT COVERSTITCH NEEDLE	CHAINSTITCH LOOPER	STITCH LENGTH	DIFFERENTIAL FEED	PRESSER FOOT PRESSURE
-	3	6.5	4	3.5	1	NORMAL

CHAINSTITCH

-  Denim, 6" x 8"
-  80/12 ELx705
-  2 Cones Serger Thread (G, P)
-  3-thread/2-needle coverstitch (wide)
-  Standard Foot

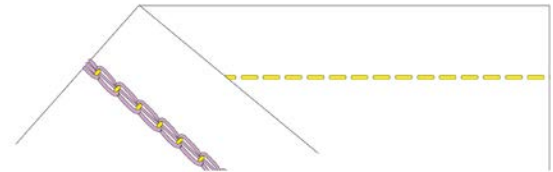

1. Set up the machine for a chainstitch using the center needle (remove the right needle and thread). Adjust settings as directed below.
2. Fold the denim to create a double fold hem and align the fabric under the presser foot, using the guidelines on the stitch plate. Place the fabric completely under the foot.
3. Stitch to the end of the fabric.
4. At the end of the stitching, carefully end and lock your stitch as described on Page 8.

THREAD TENSION SETTING				MACHINE SETUP		
LEFT COVERSTITCH NEEDLE	CENTER COVERSTITCH NEEDLE	RIGHT COVERSTITCH NEEDLE	CHAINSTITCH LOOPER	STITCH LENGTH	DIFFERENTIAL FEED	PRESSER FOOT PRESSURE
-	4.5	-	5.5	3.5	1	NORMAL

SUPPLIES

NEEDLES AND THREADS
80/12 ELX705 Serger Needles (2 come with machine)
b48: 5 Spools Serger Thread (blue, red, purple, green, yellow)
b42: 4 Spools Serger Thread (purple, blue, green, yellow)

FABRICS FOR EXERCISES		
QUANTITY	SIZE	FABRIC
2 for b48 1 for b42	6" x 8"	Medium weight denim
1	4" x 8"	Sweatshirt knit
1	4" x 8"	Medium weight cotton
1	6" x 8"	Jersey knit