

Firmware Release Notes

BERNINA International AG · Seestrasse 161 · CH-8266 Steckborn

Firmware Version

- b70: V6.36
- b79: V6.49

Table of contents

Firmware Version.....	1
Release Notes	2
1. General.....	2
1.1. New languages (b70, b79)	2
1.2. Information added in the tutorial (b70, b79).....	2
1.3. New messages	3
1.4. Continuous scrolling is now possible (b70, b79).....	4
2. Embroidery	5
2.1. Arabic alphabet improved (b70, b79)	5
2.2. Pictograms added in embroidery design selection (b70, b79)	5
2.3. Deleting designs from USB stick corrected (b70, b79)	6
2.4. Vertical mirroring improved (b70, b79)	6
2.5. Design corrected (b70, b79).....	7
3. Sewing.....	7
3.1. The stitch pattern will not reset with auto thread cutter (b79).....	7
3.2. @ symbol added in sewing alphabet (b79).....	8
Previous versions	8

Release Notes

1. General

1.1. New languages (b70, b79)

Two languages have been added for the user interface. (Swedish and Norwegian)



1.2. Information added in the tutorial (b70, b79)

Several texts have been added in the tutorial.

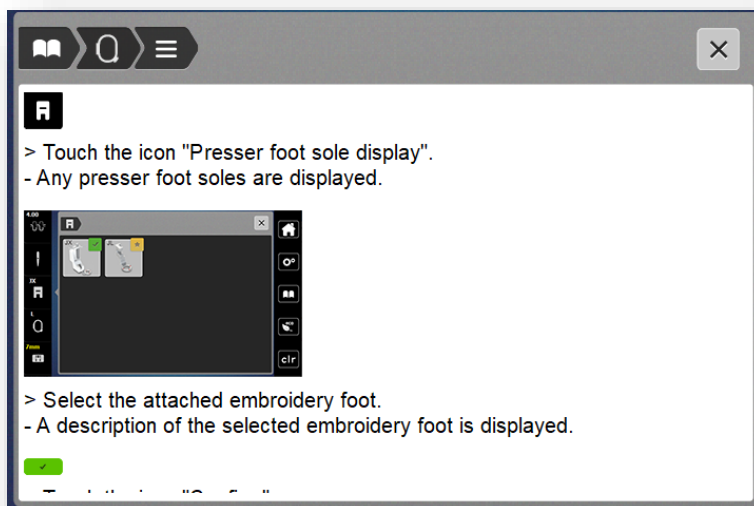

1.3. New messages

A new message has been added to remind the user to change the bobbin case when changing to embroidery or sewing mode.

This message applies only to b79 machines including the new High Thread Tension Bobbin Case (HTTBC).

When using the standard bobbin case, it might be necessary to reduce the thread tension for optimal embroidery results.



A new message has been added to remind the user to clean after 500'000 stitches. (b70, b79)

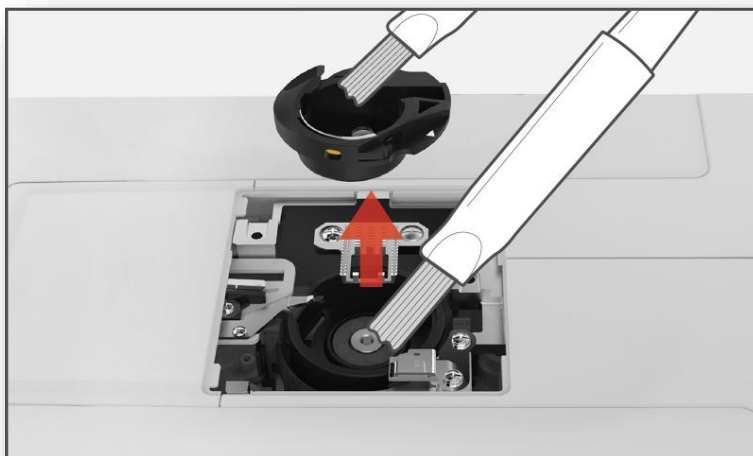

By pressing the “Cancel” button, the user will be reminded when machine is restarted.
By pressing the “Confirm” button, the message will no longer be displayed until the next 500'000 stitches have been reached.

A new message has been added to remind the user about maintenance of machine after 4'000'000 stitches. (b70, b79)

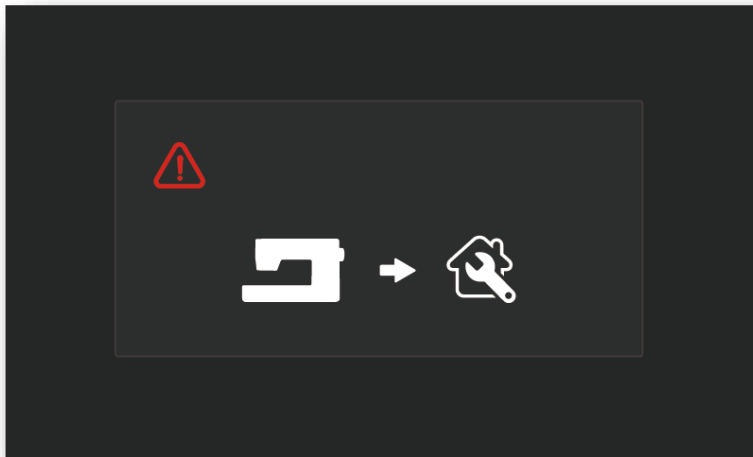

By pressing the “Cancel” button, the user will be reminded when machine is restarted. By pressing the “Confirm” button, the message will no longer be displayed until the next 4'000'000 stitches have been reached. An icon will still be displayed in the software version page until it is reset by a technician after maintenance has been done.

1.4. Continuous scrolling is now possible (b70, b79)

Continuous scrolling is now possible when arrow buttons are pressed.



2. Embroidery

2.1. Arabic alphabet improved (b70, b79)

The Arabic alphabet has been improved to create words.

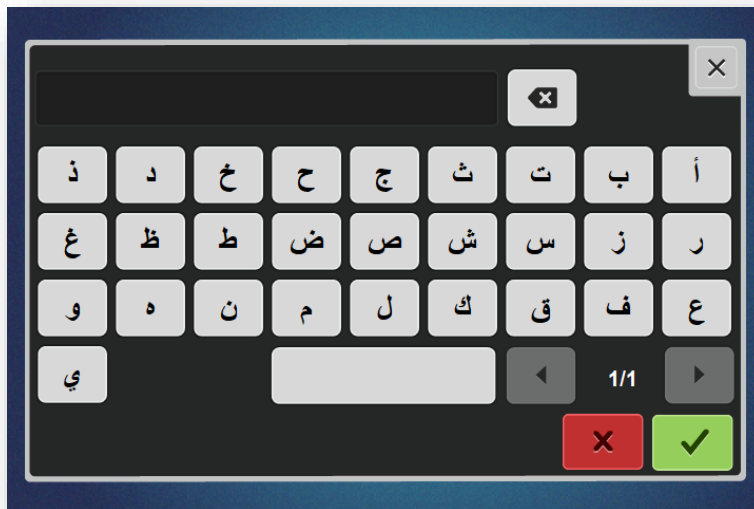

2.2. Pictograms added in embroidery design selection (b70, b79)

Pictograms have been added in the embroidery design selection to show designs with special effects ([Freestanding lace](#), [Appliqué](#), [Fringe embroidery](#), [CutWork Design](#))

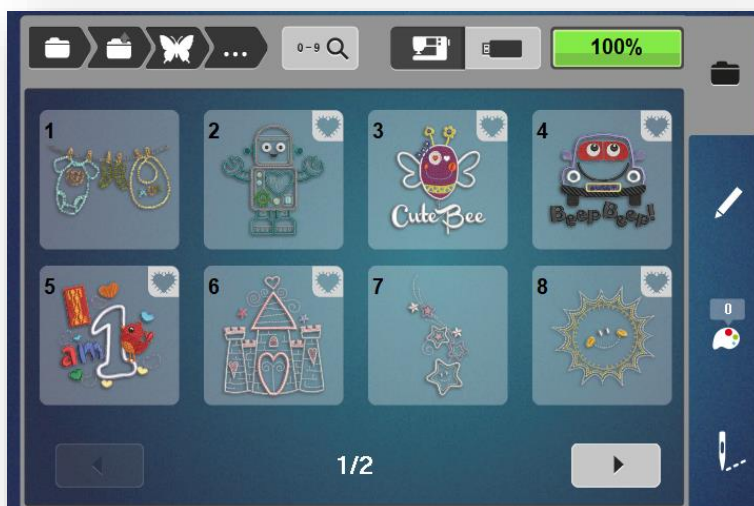

2.3. Deleting designs from USB stick corrected (b70, b79)

When designs are deleted from a USB stick, the graphic file is also deleted.

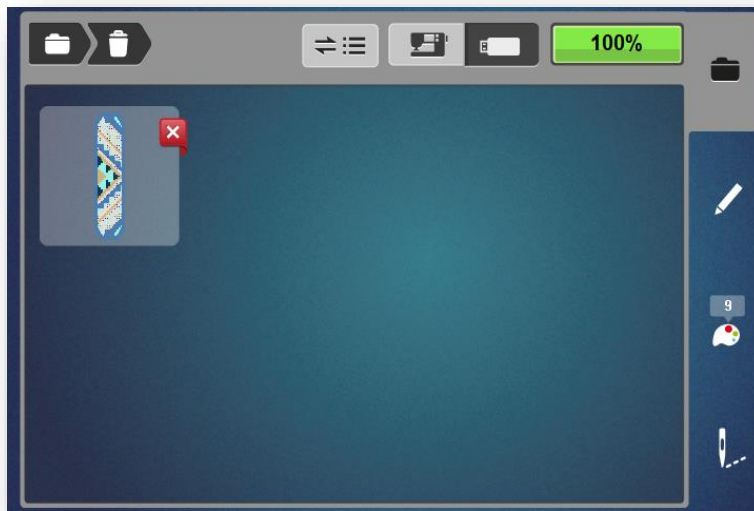

2.4. Vertical mirroring improved (b70, b79)

The vertical mirroring in combination with the bending function was improved.

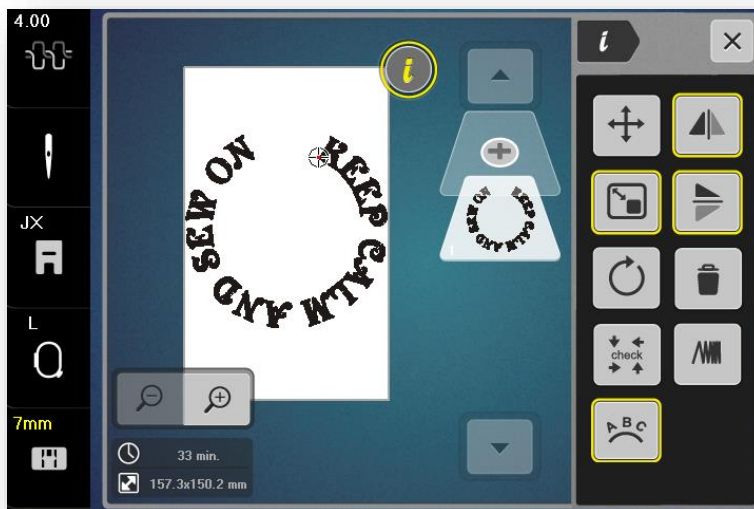

2.5. Design corrected (b70, b79)

Design 20 from folder 6 was corrected.

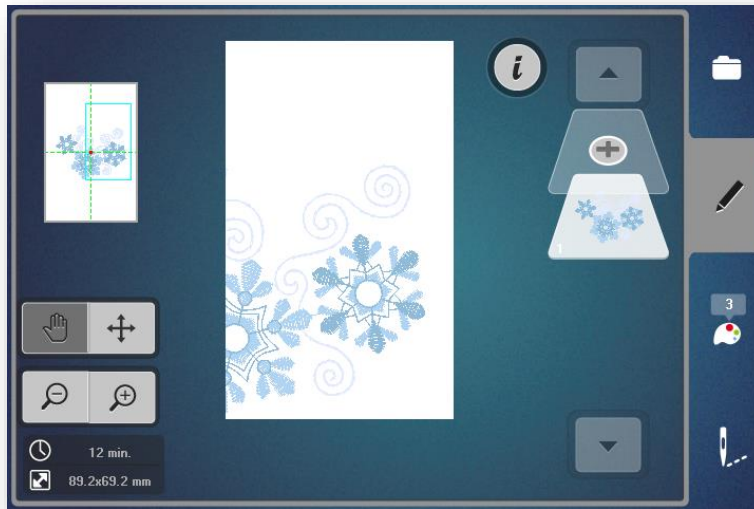

3. Sewing

3.1. The stitch pattern will not reset with auto thread cutter (b79)

The stitch pattern will no longer go back to the starting point when the auto thread cutter is used.

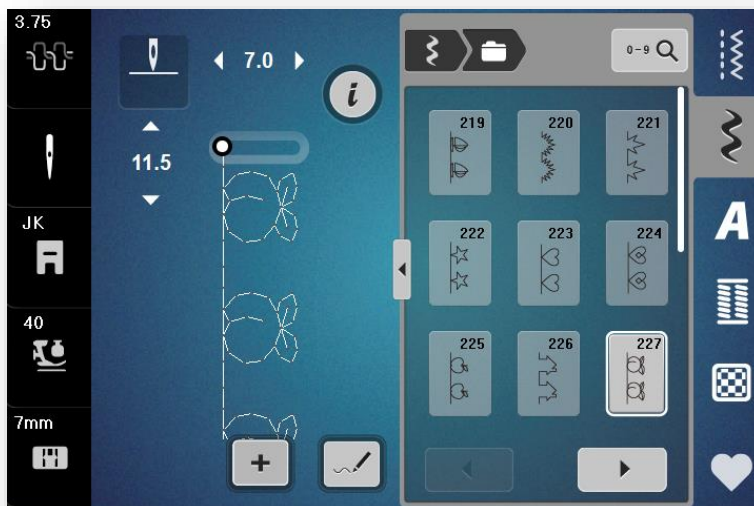

3.2. @ symbol added in sewing alphabet (b79)

The @ symbol has been added in the block and script alphabets.



Previous versions

- b70: V1.22, V2.25, V3.28, V5.34
- b79: V1.26, V2.31, V3.38, V5.45